

Radium™

216MHz

user guide

920SR speaker

921T body-worn transmitter

922T handheld transmitter

923C charging stand

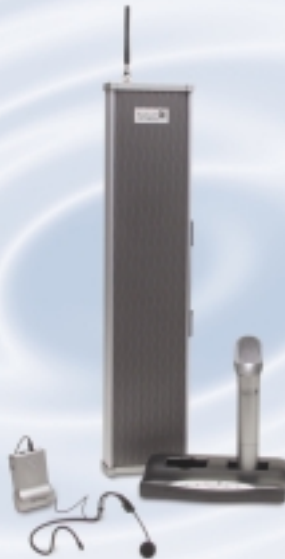

 **Phonic Ear®**

contents

| | |
|---|-------|
| introduction | 1 |
| understanding sound field | 2 |
| installation tips | 3 |
| basic system guidelines | 4 |
| accessories included with system | 5-6 |
| 920SR column speaker features | 7-10 |
| 921T body-worn transmitter features | 11-12 |
| 922T handheld transmitter features | 13 |
| 923C charging stand features | 14 |
| basic system setup and operation | 15-23 |
| 920SR speaker placement and mounting | 24-27 |
| 921T body-worn transmitter operation | 28-33 |

| | |
|---|-------|
| 922T handheld transmitter operation | 34-39 |
| connecting to auxiliary devices | 40-42 |
| additional accessories | 43-44 |
| troubleshooting | 45-46 |
| Radium channel numbers and corresponding frequencies | 47 |
| product specifications | 48-50 |
| warranty | 51-53 |
| code of federal regulations | 54-55 |
| regulatory approvals | 56-57 |

introduction

Congratulations on the purchase of your new Radium sound field system! With proper care and use it will become one of your most valuable classroom educational tools. Students will be able to consistently and easily understand the teacher, regardless of their location in the classroom, or competing internal or external background noise. Teachers can speak all day in their normal voice, and will suffer far fewer vocal problems and absenteeism.

Numerous studies show that classrooms using sound field enjoy better student comprehension, increased student participation, better grades and fewer behavioral referrals.

Read this manual carefully to become familiar with your system and to get the most out of it's many features and options.

understanding sound field and its benefits

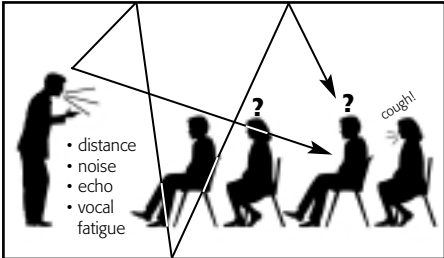

without sound field

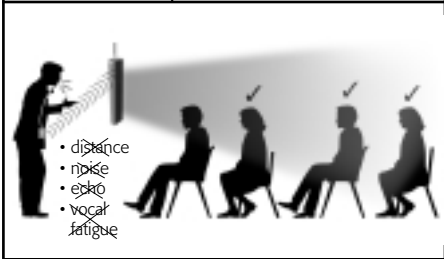

with sound field

installation tips

Before you set your system up, take a good look around your room. Where are the outlets located? Where are the computers and other electronic equipment? Where can you put your speaker so it's easy for you to reach, but out of the way of students and main traffic areas? Though each classroom is different, there are some general guidelines for speaker placement:

The speaker should be at the front of the classroom at least 6 feet/1.8 meters away from where the teacher stands. Try to keep it at least six feet away from computers or other electronic equipment, since there may be interference if placed too closely together.

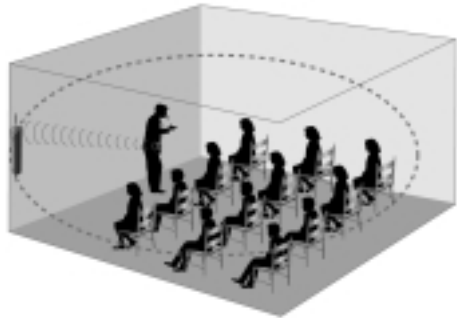

basic system guidelines

To help ensure that you get the most from this system, we have put together a list of suggested guidelines.

Charge transmitter batteries every night. Our rechargeable Nickel Metal Hydride batteries last approximately 12 hours between charges, but should be recharged every night so they are ready to go in the morning. Plan on buying new NiMH batteries after 12 months of use. Alkaline batteries can also be used, and they will last approximately 15 hours. NEVER attempt to recharge alkaline batteries! This will cause damage to the transmitter units and may invalidate product warranty.

Charge the 920SR receiver batteries every night. The column speaker rechargeable battery lasts approximately 5-8 hours between charges, but should be recharged every night so it's ready to go in the morning. For daily use, we recommend unplugging the power supply cord, allowing the battery to power the unit. Continuous, daily operation with the power supply cord plugged in will reduce the life of the battery significantly.

Do not coil the microphone cord. Since it also acts as your antenna, coiling or wrapping the cord will affect its range and may also reduce its life.

Speak at a normal level — the system is projecting your voice for you.

accessories included with system

1



2



or



3



4



5



6



7



or



8



9



10



11



12



- ① column speaker receiver
(920SR)
- ② body-worn transmitter
(921T)
or
handheld transmitter
(922T)
- ③ charging stand
(923C)
- ④ power supply, receiver
(040-7402-106)
- ⑤ power supply, charging stand
(040-7402-107)
- ⑥ receiver antenna
(AT0831)
- ⑦ speaker table stand
(AT0823)
or
wall mounting bracket (set of 2)
(AT0820)
- ⑧ elastic belt
(AT0712)
- ⑨ AA rechargeable NiMH batteries
(AT0807)
- ⑩ channel changer screwdriver
(330-3000-101)
- ⑪ auxiliary input/output cable
(AT0532-05)
- ⑫ auxiliary input cable (3.5mm – dual RCA)
(300-6332-107)

920SR column speaker features (top)

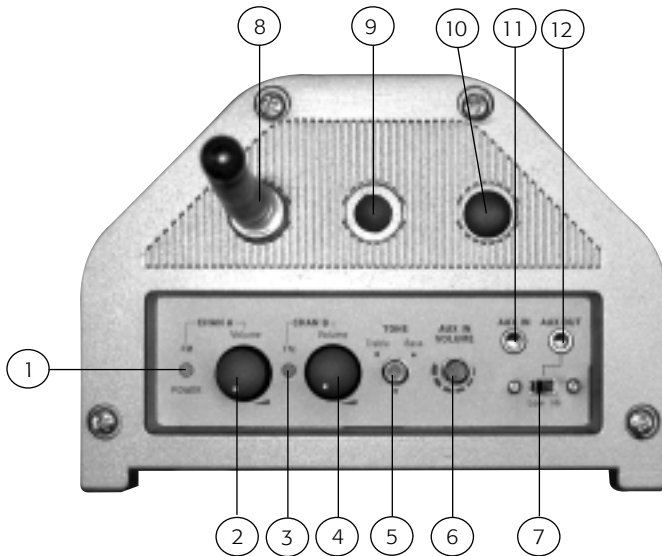

- ① power, low battery, and reception status indicator for channel A
- ② power switch and volume control for channel A
- ③ reception status indicator for channel B
- ④ power switch and volume control for channel B
- ⑤ tone control
- ⑥ aux input volume control
- ⑦ aux output level switch
See page 42 for level setting chart
- ⑧ antenna
- ⑨ wall mount hole
- ⑩ extra antenna hole (not used)
- ⑪ aux input jack (3.5mm, mono)
- ⑫ aux output jack (3.5mm, mono)

920SR column speaker features (front and back)

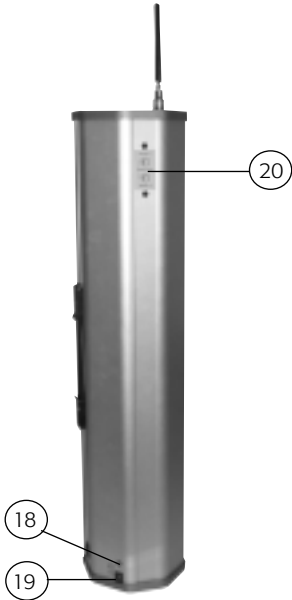
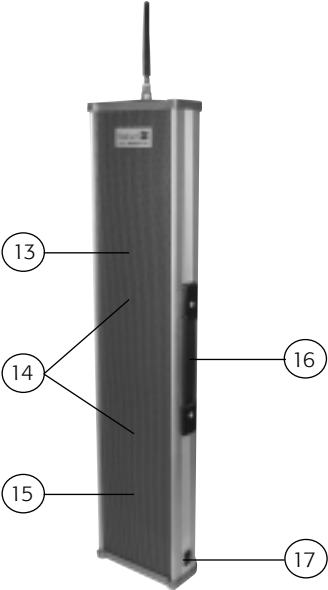

⑬ speaker grille

⑭ two built-in speakers

⑮ internal rechargeable battery
(non-user removable)

⑯ handle

⑰ main power on/off switch

⑱ power and charging indicator

⑲ power jack

⑳ channel selectors

921T body-worn transmitter features

front



back

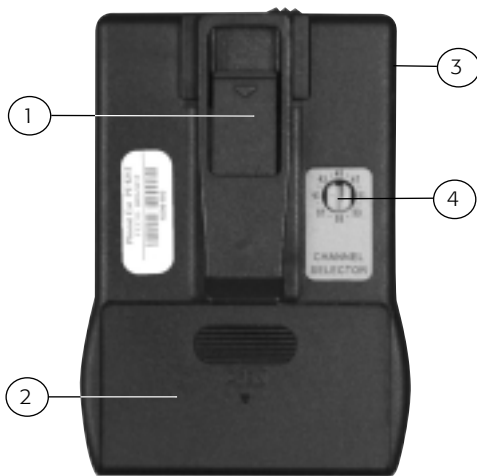

921T body-worn transmitter features (cont'd)

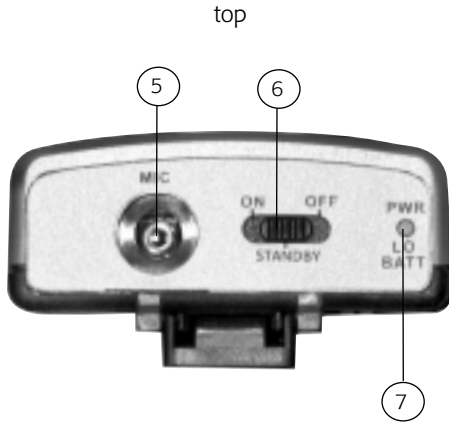

- ① belt clip
- ② battery compartment
- ③ volume control
- ④ channel selector
- ⑤ microphone input (2.5mm)
- ⑥ 3 position power switch
- ⑦ power and low battery indicator light

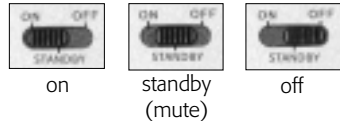

922T handheld microphone features

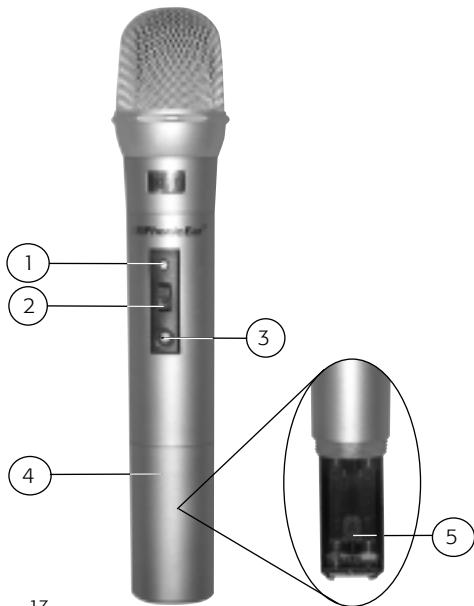

① LED indicator light

② 3 position power switch



on



standby
(mute)



off

③ channel selector

④ battery compartment

⑤ channel selector key
(inside battery compartment)

923C charging stand features

front

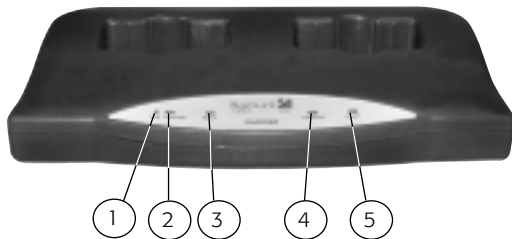

back

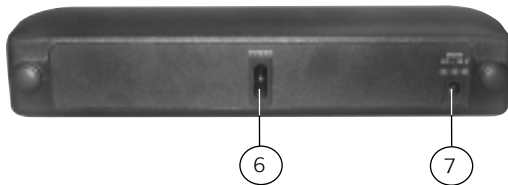

- ① power indicator
- ② pocket 1 charging indicator
- ③ pocket 1 full charge indicator
- ④ pocket 2 charging indicator
- ⑤ pocket 2 full charge indicator
- ⑥ power switch
- ⑦ DC power socket

1

basic system setup and operation

attach antenna

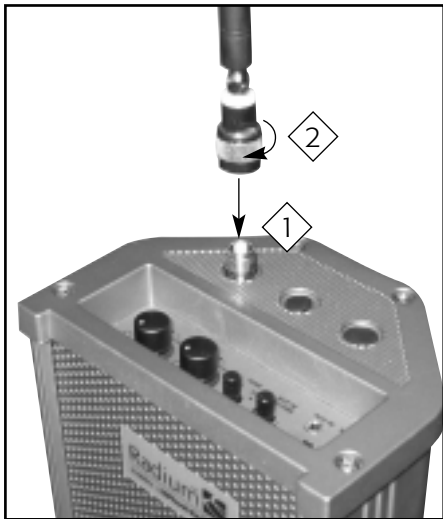

1 Attach antenna to top of speaker

2 Turn metal base of antenna clockwise until secured tightly (do not over-tighten)

2

turn on main power



if using wall outlet

- 1 Plug power supply into power/charging socket
- 2 Plug power supply into wall socket
- 3 Turn speaker on

if using already charged battery

- 3 Turn speaker on

NOTE: Battery operating time is 5-8 hours.

3

charge battery

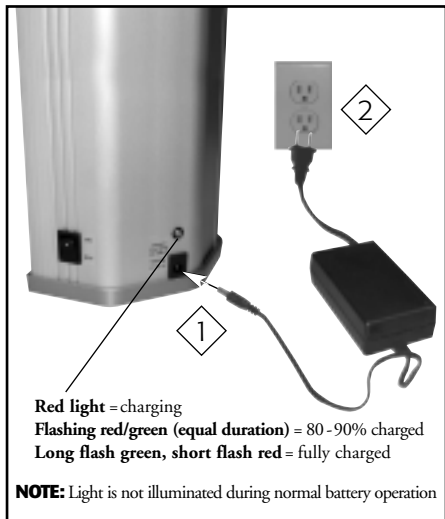

charge nightly after every use

- 1 Plug power supply into power/charging socket
- 2 Plug power supply into wall socket

Recharging time is 8 hours if the battery is completely discharged and 4 to 7 hours if battery is only partially discharged.

Continuous operation with power supply will reduce life of battery significantly.

NOTE: Battery operating time is 5-8 hours.

4

inserting batteries in body-worn transmitter

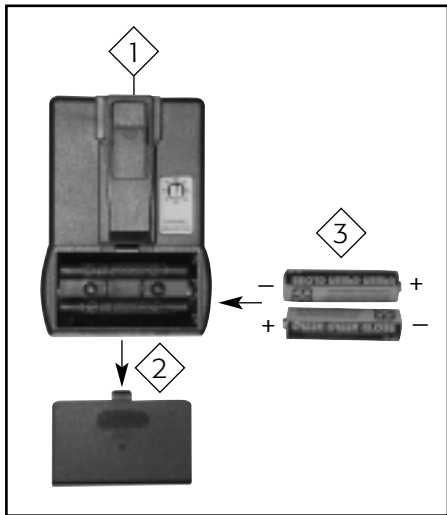

1 Switch power off

2 Remove battery cover
(*push and slide off*)

3 Insert two AA rechargeable
NiMH batteries

WARNING: Never recharge alkaline batteries! Will cause damage to the unit and may void warranty.

5

inserting batteries in handheld microphone

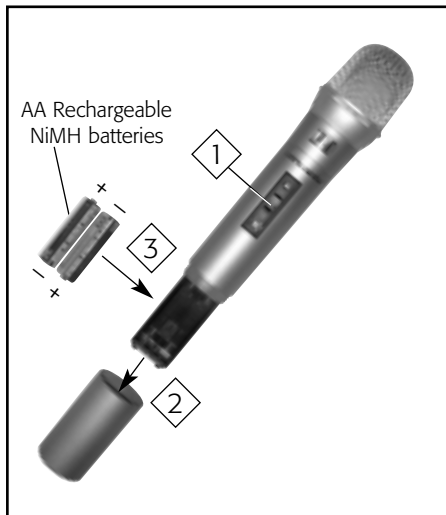

1 Switch power off

2 Remove battery cover
(*turn counter-clockwise*)

3 Insert two AA rechargeable
NiMH batteries

WARNING: Never recharge alkaline batteries! Will cause damage to the unit and may void warranty.

6

charge transmitter(s)

Never recharge alkaline batteries! May cause damage to the unit.

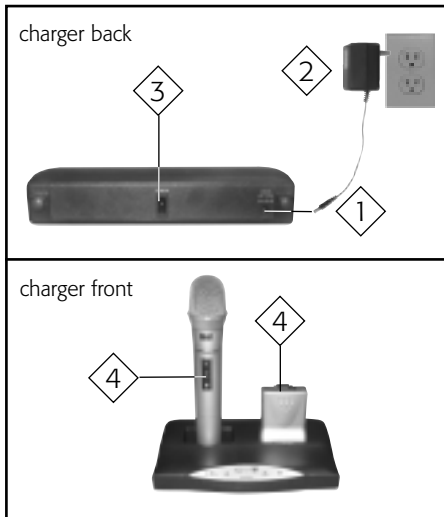

- 1 Plug power supply into power jack on back of charger stand
- 2 Plug power supply into wall socket
- 3 Turn charger on
- 4 Turn transmitters off while charging

7

wait until full charge indicators light (4-5 hours)



1

PWR:

Red light = charger is turned on

2

CHARGING:

Amber light = units are being charged

3

READY:

Green light = units are fully charged

8

select channel

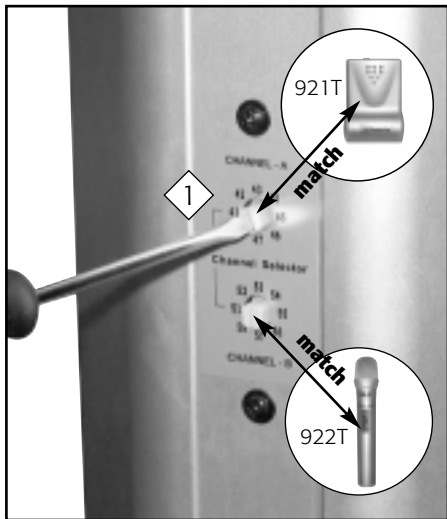

1

Use a screwdriver to adjust the **Channel A** selector on the back of the speaker to match the channel number of either the 921T and/or the 922T transmitter(s).

9

activate receivers

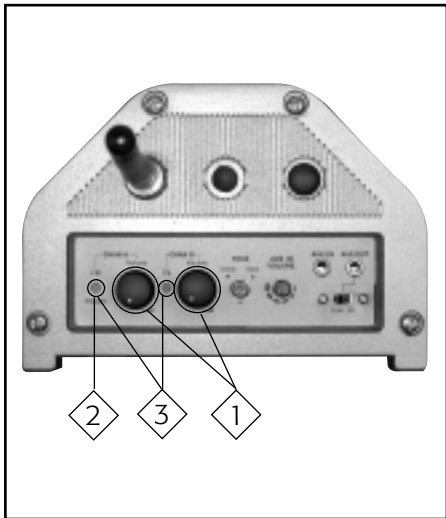

1 Turn receiver on by turning **Channel A** and/or **Channel B** volume control knob(s) to the right

2 Check power indicator light (remember tht main power must also be on – see [2]):
Flash red once = adequate power
Continuous red = low battery
No light = battery does not have power and requires recharging or power supply is not connected properly

3 Turn on a 921T or 922T transmitter and check FM indicator light(s):
Green = receiving FM signal

10

920SR speaker placement and mounting

speaker positioning

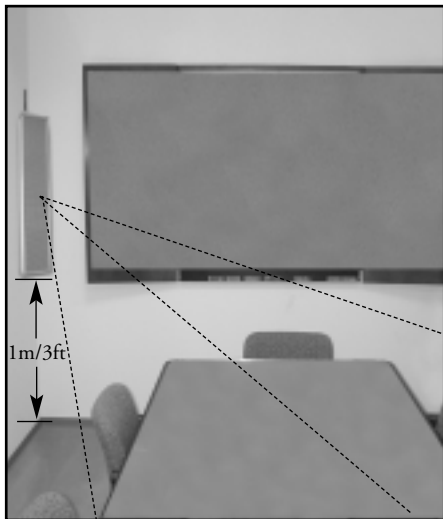

Place speaker in a corner of the room facing listeners. Mount speaker on wall using brackets or place speaker on a surface using a speaker stand. The bottom of the speaker should be about 1 meter/3 feet from the floor.

11a

wall mounting (option 1)

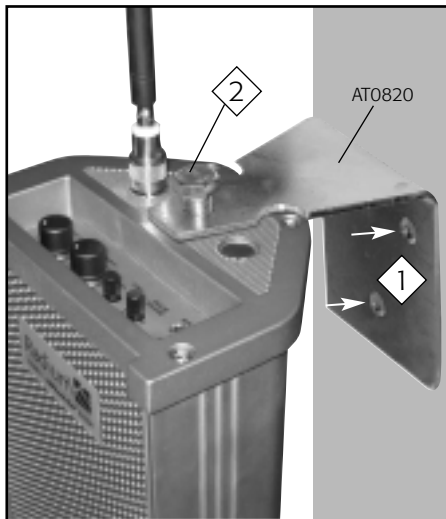

1 Attach brackets to wall

2 Screw mounting brackets to top and bottom of speaker

11b

mounting on floor stand (option 2)

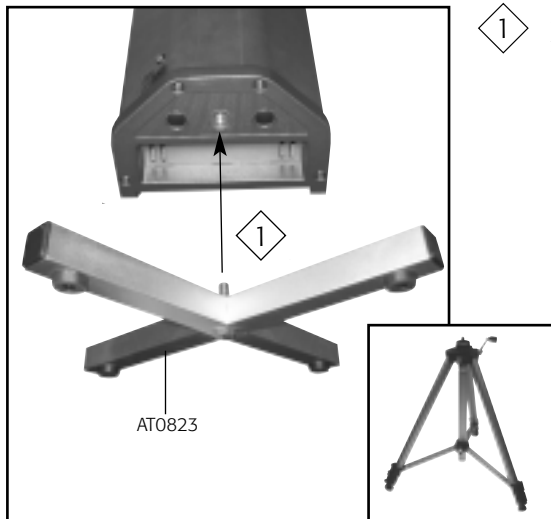

1

Screw speaker stand into hole on bottom of speaker.

- Turn clockwise to tighten
- Turn counter-clockwise to loosen

AT0824 floor stand
is also available

11c

seal wall mounting hole if using table stand

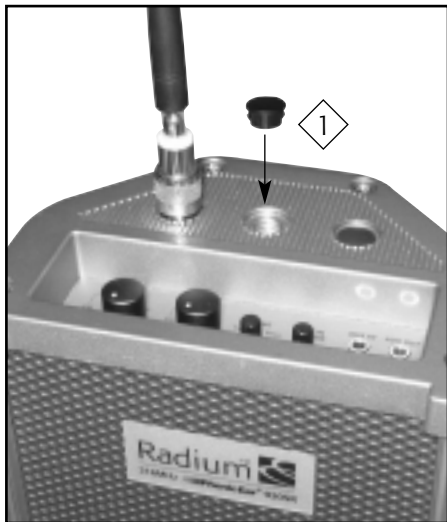

- 1 Place plastic plug into mounting bracket hole on top of speaker to keep out dust

12

921T body-worn transmitter operation

plug microphone in

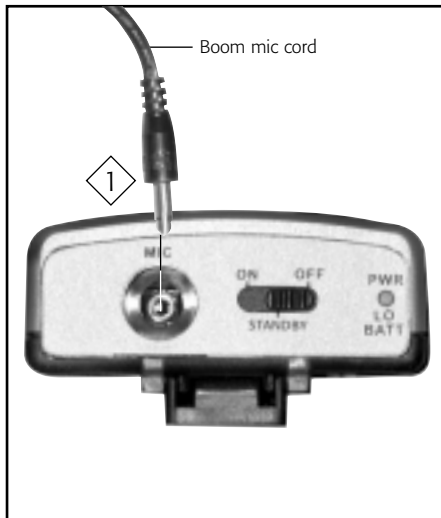

1

Plug microphone cord into **mic** jack on top of body-worn transmitter

13

put on microphone and adjust for proper distance from mouth

Maximum distance from mic to mouth is 6 in/(15cm); 3 in/(7.5cm) is ideal.



optimum
AT0655 boom mic (two wearing options)

★★★★★



AT0814 earhook mic

★★★★★

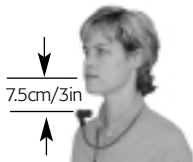

AT0816 collar mic

★★★



AT0291-L directional lapel mic

★★

14

turn power on

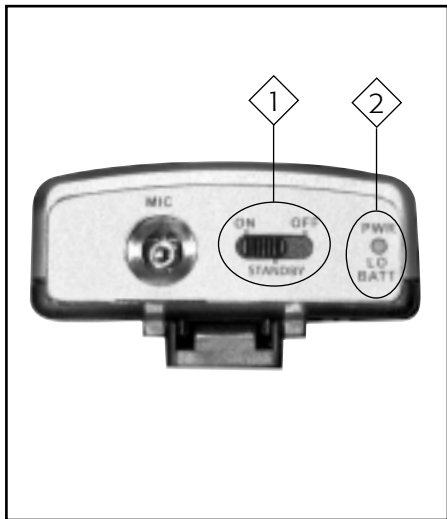

1

Switch power on

2

Check indicator light:

Continuous green = adequate power

Continuous red = low battery

battery life

NiMH rechargeable AA = 20 hours, typical

Alkaline disposable AA = 23 hours, typical

WARNING: Never recharge alkaline batteries! Will cause damage to the unit and may void warranty.

15

adjust transmitter(s) frequency

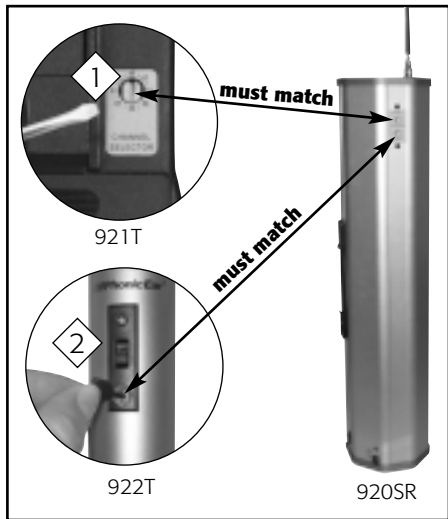

- 1 Use a screwdriver to turn frequency selector to channel number that matches the channel set on column speaker
- 2 If using both body-worn and hand-held transmitters set one transmitter channel to match a **Channel A** on the speaker column, and the other transmitter channel to match a **Channel B** channel on the speaker column.

NOTE: Never operate two transmitters on the same channel or interference will result. To use two transmitters, set the first to match receiver **Channel A** and the second to match receiver **Channel B**.

16

adjust body-worn transmitter volume

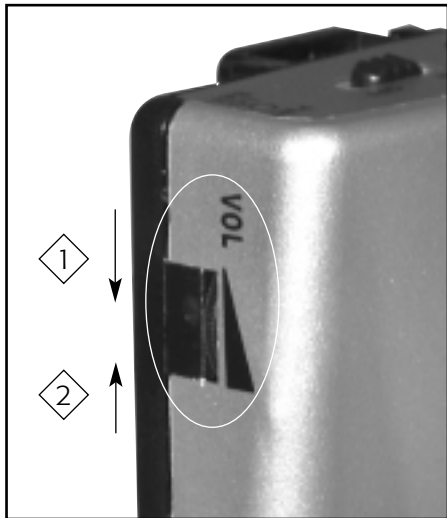

Increase transmitter volume for greater mic sensitivity and sound clarity



Reduce transmitter volume if feedback occurs

17

activate standby/mute mode

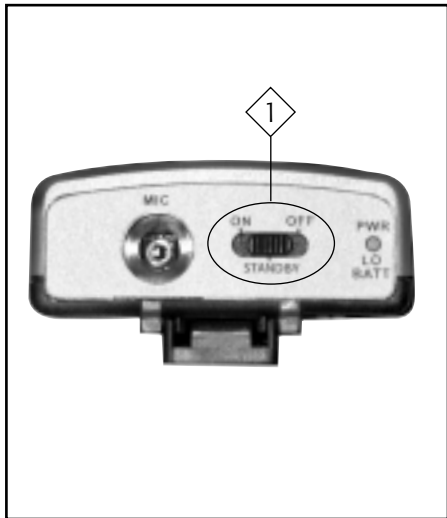

1

Activate **standby** mode to eliminate white noise when not speaking

NOTE: Standby mode can also be used as a microphone/transmitter mute switch. The mute feature allows teachers to have a private conversation without needing to turn the transmitter **off**.

18

922T handheld transmitter operation

turn power on



Turn power on by pushing power switch up

19

check indicator light

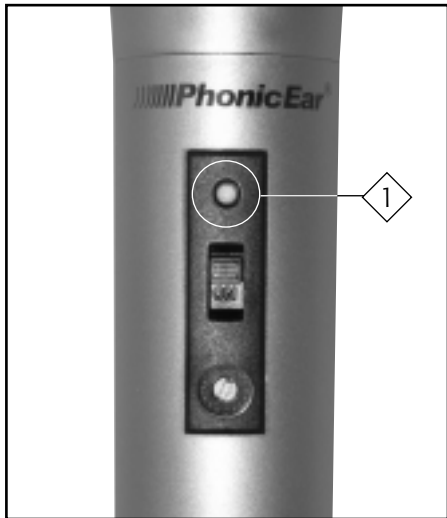

1

Check indicator light:

Continuous green = adequate power

Continuous red = low battery

battery life

NiMH rechargeable AA = 23 hours, typical

Alkaline disposable AA = 27 hours, typical

WARNING: Never recharge alkaline batteries! Will cause damage to the unit and may void warranty.

20 remove channel adjustment key

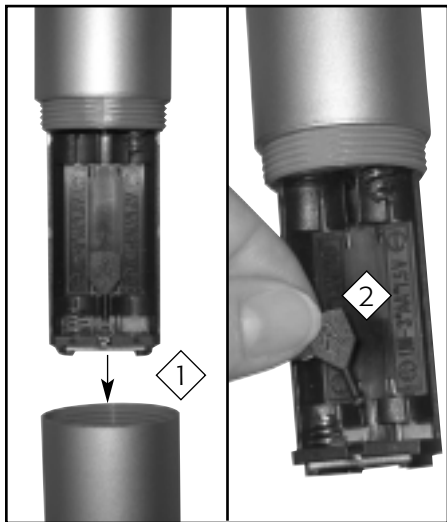

- 1 Open battery compartment door and remove batteries
- 2 Remove channel adjustment key

21

adjust transmitter channel to match receiver channel



1

Using adjustment key, turn channel frequency selector to channel number that matches the channel set on column speaker

NOTE: Never operate two transmitters on the same channel or interference will result. To use two transmitters, set the first to match receiver **Channel A** and the second to match receiver **Channel B**.

22

standby mode



1

Activate standby mode to mute voice and eliminate white noise when not speaking

1

23

transmitters that can be used with 920SR receiver/speaker

★★★★ = most compatible ★ = least compatible

| transmitter | compatible (no adaptor cord required) | performance rating | accessory needed | comments |
|-------------------------------|---|-----------------------|---------------------|---|
| 921T Radium | ✓ | ★★★★ | none | |
| 922T Radium | ✓ | ★★★★ | none | |
| 330T EasyListener 2 | ✓ | ★★★★ | none | |
| 300TS-216 Sprite | ✓ | ★★★ | none | best when used with AT0655 boom mic |
| Lexis transmitter (as mic) | ✓ | ★★★ | ✓ | a) Lexis requires the use of the AT0655R boom mic b) may require use of external antenna for better range (389-02-120-02) c) set microphone to omni mode  d) set sensitivity level to HI |
| Phonak Campus S TX5 | ✓ | ★★★ | ✓ | due to feedback, use of external boom mic from Phonak is recommended |
| Phonak HandyMic TX3 | N/A | N/A | N/A | a) built-in mic prone to feedback b) requires use of external mic, which the HandyMic does not accommodate |

24

connecting to auxiliary devices

connecting speaker to VCR

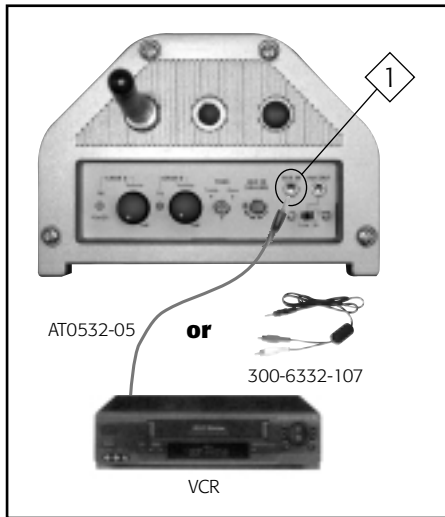

1

Using either the AT0532-05 or 300-6332-107 adaptor cords, connect VCR, TV, CD, computer or other audio source to **AUX IN** port on top of speaker

25

connecting to SOLARIS, EASY LISTENER, SPRITE or other transmitter
(for rebroadcast of audio to students with hearing impairment)

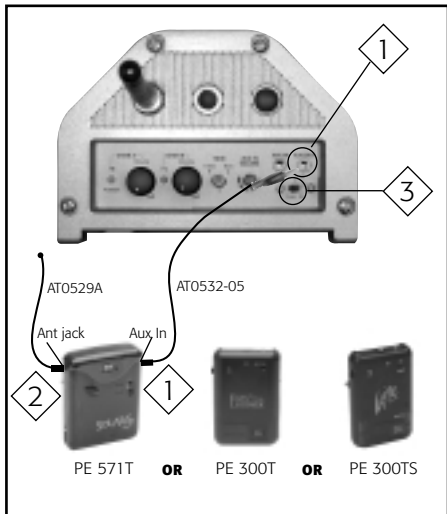

- 1 Connect AT0532-05(ft) cord to **AUX** input jack of either SOLARIS, EASY LISTENER, SPRITE, or other transmitter. Connect other end of cable to **AUX OUT** port on top of speaker.
- 2 Connect antenna AT0529A (included with transmitter system) to **Mic/Ant** jack on transmitter
- 3 Refer to level setting guide on next page to identify proper level for your transmitter

26

aux out transmitter compatibility chart and level setting guide

NOTE: Common transmitters and recommended level settings are shown below. Because the level setting is universal, other transmitters not listed below may be used as well – simply set the **aux out** level to the position control until the receiver wearer hears a strong distortion-free signal.

| product name/part | aux in jack size | aux out level setting |
|------------------------|------------------|-----------------------|
| Easy Listener 330T | 3.5mm | High |
| Sprite 300TS | 3.5mm | High |
| Sprite 300TS-216 | 3.5mm | High |
| Solaris 571T | 3.5mm | High |
| Lexis 871T transmitter | 3.5mm* | High |
| Phonak Campus TX5 | 3.5mm* | High |
| Phonak HandyMic TX3 | 3.5mm*† | High |
| Phonak MicroVox TX2 | 2.5mm | High |

* For transmitters with a 3.5mm jack size, simply attach the transmitter to the AT0805 aux out accessory cord. For 2.5mm products, use the aux out adapter plug (310-2544-1341) 

† Requires special adaptor cord provided by Phonak

additional system accessories

microphone options

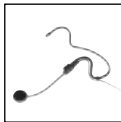

AT0655
behind-the-neck
boom microphone



AT0814
earhook microphone



AT0816
FM collar microphone
with mute switch

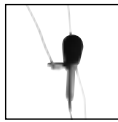

AT0291-L
directional microphone
with lavalier cord

receiver accessories



AT0820
wall mounting bracket
(set of 2)

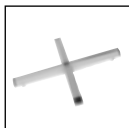

AT0823
speaker table stand



AT0824
speaker floor stand



AT0822
carrying bag



AT0801
aux-box (adds four
additional audio inputs)

additional system accessories (cont'd)

transmitter accessories

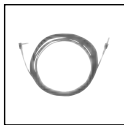

AT0532-15
auxiliary input/
output cable
(3.5mm-dual RCA)
(15ft/4.6m)



AT0529A
transmitter antenna



310-2544-1341
aux-out adaptor plug
(3.5mm-2.5mm)

troubleshooting

no FM reception (Channel A, Channel B indicator does not have green light)

- Verify the transmitter is turned on
- Verify the frequency number on the transmitter matches the frequency number on receiver
- Verify transmitter batteries are charged
- Verify speaker antenna is connected properly

weak sound from speaker

- Increase volume on the speaker
- Turn up transmitter volume (922T only)
- Make sure AT0655 boom microphone (or other mic) is being worn correctly

speaker is receiving a signal but no sound is coming out

- Verify microphone is connected properly to transmitter and is working correctly

feedback from speaker

- Turn down the volume on the transmitter (922T only)
- Turn down the volume on the speaker
- Make sure the person wearing the transmitter is not too close to the speaker
- Move speaker so that it is facing away from presenter and toward listeners
- Make sure AT0655 boom microphone (or other mic) is being worn correctly

troubleshooting (cont'd)

speaker does not turn on (power indicator does not flash red)

- Verify main power switch on the bottom of the unit is turned on
- Verify Channel A and Channel B volume control knobs are turned on
- Verify power supply is plugged securely into speaker and wall socket
- Verify wall socket works

speaker battery does not charge

- Connect power supply to speaker and charge for four hours. If speaker battery does not hold a charge, send the unit to Phonic Ear Service department for replacement (battery must be replaced after one year of continuous use).

speaker is picking up FM interference or hum

- Check to make sure no other wireless systems are operating on similar frequencies
- Check to make sure the system is not placed too close to a computer
- Check to make sure metal objects are not placed too close to transmitter or speaker (i.e. jewelry, metal shelves)

Radium channel numbers and corresponding frequencies

| Channel # | Channel A | Channel # | Channel B |
|------------------|------------------|------------------|------------------|
| 41 | .216.025 MHz | 51 | .216.525MHz |
| 42 | .216.075MHz | 52 | .216.575MHz |
| 43 | .216.125MHz | 53 | .216.625MHz |
| 44 | .216.175MHz | 54 | .216.675MHz |
| 45 | .216.225MHz | 55 | .216.725MHz |
| 46 | .216.275MHz | 56 | .216.775MHz |
| 47 | .216.325MHz | 57 | .216.825MHz |
| 48 | .216.375MHz | 58 | .216.875MHz |

product specifications

two channel column speaker: 920SR

| | |
|---|---|
| carrier frequency range/ frequencies | 216.025–216.875MHz 16 total |
| modulation | FM (F3E) |
| output power | maximum 36W @ 4Ω x 2 |
| power requirements | 110V/240V AC adaptor 15V DC/2A, Battery 12V/2.7A (rechargeable, sealed lead-acid, 1-1.5 year life with continuous usage) |
| frequency response | 100Hz – 9kHz |
| total harmonic distortion | <2% |
| system signal-to-noise ratio | >65 dB (at rated output) |
| inputs | AUX x 1, power & charge |
| output | AUX x 1 (High: 700 mV/Low: 100mV) |
| controls | tone, channel A & channel B power/volume, aux volume, high/low output, master power, channel selector |

| | |
|------------------------|--|
| dimensions (wxhxd) | 100 x 660 x 145 mm/ 3.9 x 26 x 5.7 in |
| weight | 5kg/11lbs |
| recharging time | 8 hours for initial charging 4–7 hours for recharging |
| battery operating time | 5–8 hours (continuous operation) |
| speaker stand | optional table stand (AT0823), floor stand (AT0824), or wall brackets (AT0820) |
| de-emphasis | 75μs |
| squelch | RSSI |

product specifications (cont'd)

body-worn transmitter: 921T

| | |
|---|--|
| carrier frequency range/ frequencies | 216.025 – 216.875MHz 16 total |
| modulation | FM (F3E) |
| total harmonic distortion | <1.5% |
| frequency response | 50Hz to 12KHz |
| frequency stability | .0005% |
| maximum modulation | ± 25KHz, with level limiting |
| pre-emphasis | 75µs |
| dynamic range | 100dB |
| operating range | >34m/110ft |
| dimensions (WXHXD) | 65 x 90 x 25 mm/ 2.5 x 3.5 x 1 in |
| weight | 51g/1.8oz |
| controls | on/standby/off/channel selector/volume |
| inputs/outputs | 2.5mm microphone input jack |

| | |
|-----------------|--|
| battery | NiMH rechargeable (1600mA); alkaline disposable (2AA) |
| battery life | NiMH rechargeable: 20 hours typical alkaline disposable: 23 hours typical |
| recharging time | 6 hours |

product specifications (cont'd)

handheld mic transmitter: 922T

| | |
|---|--|
| carrier frequency range/ frequencies | 216.025 – 216.875MHz 16 total (see chart below) |
| mic | dynamic microphone |
| antenna | built-in |
| RF output | 15mW |
| battery | NiMH rechargeable battery; alkaline disposable; 1.5V x 2 AA |
| battery life | NiMH rechargeable: 23 hours typical alkaline disposable: 27 hours typical |
| recharging time | 6 hours (NiMH batteries) |
| dimensions (dia x length) | 54 x 237 mm/2.1 x 9.3 in |
| weight | 230g/8.1oz |
| controls | on/standby/off/channel selector |

charging stand: 923C

| | |
|--------------------|--|
| power supply | AC adaptor (DC 12V/0.5A) |
| indicator lights | LED green = battery ready LED orange = recharging LED red = power on |
| recharging time | NiMH (1300mA): 4 hr |
| dimensions (WXHXD) | 135 x 47 x 230 mm/5.3 x 1.9 x 9 in |
| weight | 360g/12.7oz |
| controls | on/off switch |

warranty

time period of warranty

This warranty will go into effect upon the date of purchase and will stay in effect as long as the instrument remains the property of the original owner. EASYLISTENER 2™, VOCALIGHT™ and ONWAVE™ have a 3-year warranty. All other products have a 1 year warranty.

what is covered by this warranty

Any electronic component, which because of workmanship, manufacturing or design defects, fails to function properly under normal use during the life of this warranty will be replaced or repaired at no charge for parts or labor, when returned to the factory service center. Transportation is paid by the customer. If it is determined that repair is not feasible, the entire unit may be replaced with an equivalent unit upon mutual agreement of the manufacturer and customer.

what is not covered by this warranty

This limited warranty does not apply to:

- 1.** Malfunctions resulting from abuse, neglect or accident
- 2.** Instruments connected, installed, used or adjusted in any manner contrary to instructions provided by the manufacturer
- 3.** Consequential damages and damages resulting from delay or loss of this instrument. The exclusive remedy under this warranty is strictly limited to repair or replacement as herein provided
- 4.** Products damaged in transit unless investigated by the shipper and returned to the warrantor with the investigation report
- 5.** Peripheral accessories as itemized within the product specification sheet as applicable, when such items are not returned within 1 year from original purchase
- 6.** Batteries if applicable

warranty (cont'd)

Phonic Ear Inc. reserves the right to make changes in the design or construction of any of its instruments at any time without incurring any obligation to make any changes whatsoever on units previously purchased.

This warranty is in lieu of all other expressed warranties. All expressed and implied warranties will terminate upon the expiration of this written warranty. No representative or person is authorized to represent or assume for us any liability in connection with the sale or use of our products other than as set forth above.

what to do if you have questions

If you have any questions about service, call the service department at **800.227.0735, then press 7.**

what to do if you need service

If you require service under the warranty terms, obtain a service order form either online at **www.phonicear.com/support.asp** or through our U.S. customer service department at **800.227.0735, then press 5** (or +1.707.769.1110 outside the U.S.). Fill the form out completely remembering to include:

- 1.** Description of the problem
- 2.** Your billing address
- 3.** Your shipping address (if different from billing address)
- 4.** Contact name and phone number
- 5.** A P.O. number if the equipment is not under a warranty or service contract

warranty (cont'd)

Then, carefully package the equipment in the original shipping container to prevent damage and send it postpaid to the service center near you:

USA/International:

Phonic Ear Inc.

3880 Cypress Drive
Petaluma, CA 94954-7600
U.S.A.

In Canada:

Phonic Ear Ltd.

10-7475 Kimbel Street
Mississauga, Ontario
L5S 1E7 Canada

what to do if you have questions

If you have any questions about service, call the service department at **800.227.0735, then press 7.**

about your batteries

To ensure that your batteries are as fresh as possible upon arrival, we have intentionally not installed them in your equipment.

install your batteries in your equipment now, then charge overnight before initial use

(see user guide for charging procedure).

avoid battery corrosion

To avoid battery corrosion and damage to your equipment, **do not recharge disposable or rechargeable alkaline batteries.** Before charging any Phonic Ear equipment make sure only NiCad or NiMH rechargeable batteries are installed. As an added precaution, remove batteries if the equipment will not be used for several weeks.

code of federal regulations (United States only)

21 C.F.R., part 801.420 - important notice for prospective hearing instrument users

Good health practice requires that a person with a hearing loss have a medical evaluation by a licensed physician (preferably a physician who specializes in diseases of the ear) before purchasing a hearing instrument. Licensed physicians who specialize in diseases of the ear are often referred to as otolaryngologists, otologists, or otorhinolaryngologists. The purpose of a medical evaluation is to assure that all medically treated conditions that may affect hearing are identified and treated before a unit is purchased.

Following the medical evaluation, the physician should give you a written statement which states your hearing loss has been medically evaluated, and that you may be considered a candidate for a hearing instrument. The physician should refer you to an audiologist or hearing aid dispenser, as appropriate, for a hearing instrument evaluation.

The audiologist or hearing aid dispenser will conduct a hearing instrument evaluation to assess your ability to hear with and without a hearing instrument. The evaluation will enable the audiologist or dispenser to select and fit a unit best suited to your individual needs.

If you should have reservations about your ability to adapt to amplification, you should inquire about the availability of a trial rental or purchase-option program. Many dispensers now offer programs that permit you to wear the hearing instrument for a period of time for a nominal fee after which you may decide if you want to purchase that unit.

Federal law restricts the sale of hearing instruments to those individuals who have not obtained a medical evaluation from a licensed physician. Federal law permits a fully informed adult to sign a waiver statement declining the medical evaluation for religious or personal beliefs that preclude consultation with a physician. The exercise of such a waiver is not in your best interest and its use is strongly discouraged.

code of federal regulations (cont'd)

children with hearing loss

In addition to seeing a physician for a medical evaluation, a child with a hearing loss should be directed to an audiologist for evaluation and rehabilitation since hearing loss may cause problems in language development and the educational and social growth of a child. An audiologist is qualified by training and experience to assist in the evaluation and rehabilitation of a child with a hearing loss.

transmitter

This transmitter is authorized by rule under the Low Power Radio Service (47 C.F.R. Part 95) and must not cause harmful interference to TV reception or United States Navy SPASUR installations. You do not need an FCC license to operate this transmitter. This transmitter may only be used to provide: auditory assistance to persons with disabilities, persons who require language translation, or persons in educational settings; health care services to the ill; law

enforcement tracking services under agreement with a law enforcement agency; or automated maritime telecommunications system (AMTS) network control communications. Two-way voice communications and all other types of uses not mentioned above are expressly prohibited.

This device may not interfere with TV reception or federal government radar, and must accept any interference received, including interference that may cause undesired operation.

IMPORTANT NOTE: To comply with FCC RF exposure compliance requirements, only use supplied antenna that is sold with this transmitter. Use of any other antenna which has not been approved by the manufacturer will violate FCC rules and regulation and void the user's authority to operate this device. This device and its antenna(s) must not be co-located or operating in conjunction with any other antenna or transmitter.

regulatory approvals

receiver: part 15, subpart B

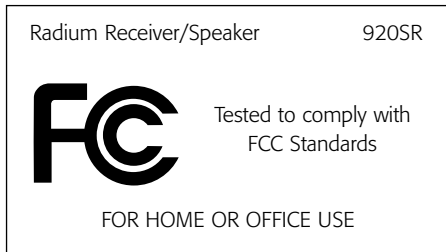

FCC notes

The Radium sound field system is approved by the FCC (Federal Communications Commission). The use of the system may be governed by specific FCC rules and FCC licensing or notifications may be required. Consult your local FCC office for detailed information.

Phonic Ear FM receivers and FM transmitters, when required, are approved by the Federal Communications Commission (FCC) in the U.S. and Industry Canada. Other government approvals are available upon request. (Other international regulations may also apply.)

Any changes or modifications made to any government-approved element of this instrument, without the express approval of Phonic Ear Inc in writing, could void the user's authority to operate those elements of the system.

The term "IC:" before the radio certification number only signifies that Industry of Canada technical specifications were met.

regulatory approvals (cont'd)

Part 95

This transmitter is authorized by rule under the Low Power Radio Service (47 CFR Part 95) and must not cause harmful interference to TV reception or United States Navy SPASUR installations. You do not need an FCC license to operate this transmitter. This transmitter may only be used to provide auditory assistance to persons with disabilities, persons who require language translation, or persons in educational settings; health care services to the ill; law enforcement tracking service under agreement with a law enforcement agency; or automated maritime telecommunication system (AMTS) network control communications. Two-way voice communications and all other types of uses not mentioned above are expressly prohibited.

This device may not cause interference and must accept any interference received, including interference that may cause undesired operation.

These devices may not interfere with TV reception or Federal Government radar.

u.s.a. **800.227.0735**, then press **5** • canada **800.263.8700** • international **+45 3917 7101**

© 2004 Phonic Ear Inc. Phonic Ear and the names of Phonic Ear products are trademarks or registered trademarks of Phonic Ear Inc. in the U.S. and other countries. Product specifications and accessories subject to change without notice.

821-7403-101/Rev. A/3850 0304